

 **SENNHEISER**

ME 34
ME 35
ME 36

Bedienungsanleitung
Instruction Manual
Notice d'emploi
Istruzioni per l'uso
Instrucciones para el uso
Gebruiksaanwijzing

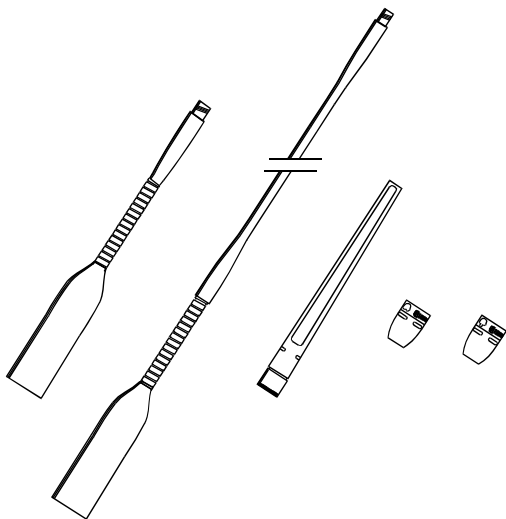

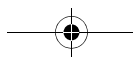
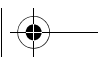
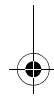
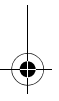
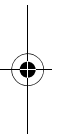
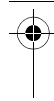
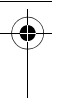
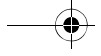

Deutsch

English

Français

Italiano

Español

Nederlands

Diagrams

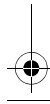
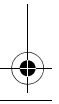
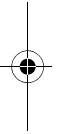
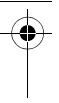

Mikrofonköpfe ME 34, ME 35, ME 36

- Dauerpolarisierte Kondensatormikrofone
- Anwendungsbereiche: Konferenz, Beschallung, Studioteknik

ME 34, ME 35

- ME 34: Nieren-Charakteristik
- ME 35: Supernieren-Charakteristik
- Stabiles Metallgehäuse, nicht reflektierende Oberfläche, mattschwarz
- Hohe Klangqualität
- Rauscharm

ME 36

- Supernieren-/Keulen-Charakteristik
- Stabiles Metallgehäuse, mattschwarz
nicht reflektierende Oberfläche
- Hoher Bündelungsgrad
- Höchste Klangqualität
- Sehr rauscharm

Anschlussmöglichkeiten

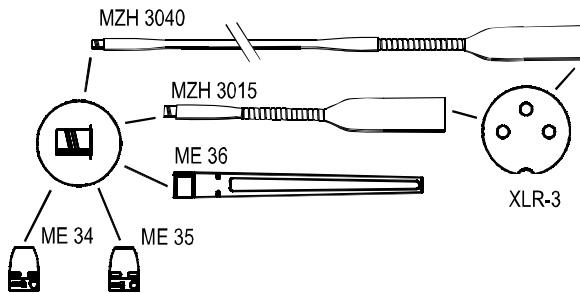

Hinweis:

Um eine intakte Masseverbindung herzustellen, schrauben Sie das Mikrofon unbedingt fest auf den Schwanenhals.

Zubehör

Artikel	Bezeichnung	Artikel-Nr.
Schwanenhäse	MZH 3015	005074
	MZH 3040	005076
	MZH 3042	009384
Windschutze	MZW 34 W weiß	005068
	MZW 34 PRO schwarz	005067
	MZW 34 schwarz	086740
	MZW 36 PRO schwarz	005069
Schwinghalterung	MZW 36 schwarz	083297
	MZS 31	005087
	Leuchtringvarianten	MZH 3015L
	MZH 3040L	009436
	MZH 3042L	009437

Schwanenhäse MZH 3015, MZH 3040 und MZH 3042

- Schwanenhäse zur Verwendung mit den Mikrofonen ME 34, ME 35 und ME 36
- Stabiler Metallhals, nicht reflektierende Oberfläche, mattschwarz
- Standardanschluss (XLR-3)

	MZH 3015	MZH 3040	MZH 3042
Länge	150 mm	400 mm	400 mm
Durchmesser (Hals)	6 mm	6 mm	6 mm
Gewicht	73 g	120 g	110 g
Anschluss	XLR-3	XLR-3	XLR-3

XLR-3 Anschlüsse

Die Ausgangsstecker der Schwanenhäse sind symmetrisch-erdfrei beschaltet und normgemäß gepolt.

Technische Daten Mikrofonköpfe

In Kombination mit MZH 3015, MZH 3040 und MZH 3042

	ME 34	ME 35	ME 36
Übertragungsbereich	40 Hz – 20 kHz	50 Hz – 20 kHz	40 Hz – 20 kHz
Akustische Arbeitsweise	Druckgradientenempfänger	Druckgradientenempfänger	Druckgradientenempfänger/ Interferenzrichtrohr
Richtcharakteristik	Niere	Superniere	Superniere/Keule
Feldleerlauf-Übertragungsfaktor	10 mV/Pa	10 mV/Pa	18 mV/Pa
Elektrische Impedanz	50 Ω	50 Ω	50 Ω
Min. Abschlussimpedanz	1 k Ω	1 k Ω	1 k Ω
Ersatzgeräuschpegel	37 dB (CCIR) 26 dB(A)	37 dB (CCIR) 26 dB(A)	34 dB (CCIR) 23 dB(A)
Stromversorgung	P12 – P48	P12 – P48	P12 – P48
Maße (mm)	\varnothing 12 x L18	\varnothing 12 x L18	\varnothing 8,2 x L96
Gewicht (ohne MZH)	9,5 g	9,5 g	17 g
Anschluss	XLR-3	XLR-3	XLR-3

Herstellererklärungen

Garantie

2 Jahre

Konformitätserklärung



Sennheiser electronic GmbH & Co. KG erklären, dass dieses Gerät die anwendbaren CE-Normen und Vorschriften erfüllt.

WEEE-Erklärung



Bitte entsorgen Sie dieses Gerät am Ende seiner Nutzungsdauer bei Ihrer örtlichen kommunalen Sammelstelle oder im Recycling Center.

ME 34, ME 35, ME 36 Microphone Heads

- Pre-polarized condenser microphones
- Areas of application: conference, public address and studio applications.

ME 34, ME 35

- ME 34: cardioid pick-up pattern
- ME 35: super-cardioid pick-up pattern
- Rugged, matt black metal housing with anti-reflection coating
- High sensitivity
- Low equivalent noise level

ME 36

- Super-cardioid/lobar pick-up pattern
- Rugged, matt black metal housing with anti-reflection coating
- Excellent directivity
- Highest sensitivity
- Very low equivalent noise level

Possible Connections

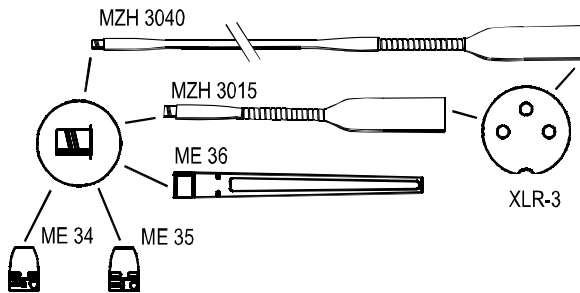

Note

To create an intact bond, make sure that you screw the microphone tightly onto the gooseneck.

Accessories

Accessories	Name	Cat.No.
Goosenecks	MZH 3015	005074
	MZH 3040	005076
	MZH 3042	009384
Windscreens	MZW 34 W white	005068
	MZW 34 PRO black	005067
	MZW 34 black	086740
	MZW 36 PRO black	005069
	MZW 36 black	083297
Shockmount	MZS 31	005087
Signal light ring variants	MZH 3015L	009435
	MZH 3040L	009436
	MZH 3042L	009437

MZH 3015, MZH 3040 and MZH 3042 Goosenecks

- Goosenecks for use with the ME 34, ME 35 and ME 36 microphones
- Rugged, matt black metal housing with anti-reflection coating
- Standard connection (XLR-3)

	MZH 3015	MZH 3040	MZH 3042
Length	150 mm	400 mm	400 mm
Diameter	6 mm	6 mm	6 mm
Weight	73 g	120 g	110 g
Connector	XLR-3	XLR-3	XLR-3

XLR-3 connectors

The goosenecks feature balanced and floating XLR outputs with standard polarity.

Technical Data

In combination with MZH 3015, MZH 3040 and MZH 3042

	ME 34	ME 35	ME 36
Frequency response	40 Hz – 20 kHz	50 Hz – 20 kHz	40 Hz – 20 kHz
Acoustic operating principle	pressure gradient transducer	pressure gradient transducer	pressure gradient transducer/ interference tube transducer
Pick-up pattern	cardioid	super-cardioid	super-cardioid/ lobar
Sensitivity (free field, no load)	10 mV/Pa	10 mV/Pa	18 mV/Pa
Electrical impedance	50 Ω	50 Ω	50 Ω
Min. terminating impedance	1 k Ω	1 k Ω	1 k Ω
Equivalent noise level	37 dB (CCIR) 26 dB(A)	37 dB (CCIR) 26 dB(A)	34 dB (CCIR) 23 dB(A)
Power supply	P12 – P48	P12 – P48	P12 – P48
Dimensions in mm	\varnothing 12 x L18	\varnothing 12 x L18	\varnothing 8.2 x L96
Weight (without MZH)	9,5 g	9,5 g	17 g
Connector	XLR-3	XLR-3	XLR-3

Manufacturer declarations

Warranty

2 years

Approval



CE Sennheiser electronic GmbH & Co. KG declare that this device is in compliance with the applicable CE standards and regulations.

WEEE Declaration



Please dispose of this product at the end of its operational lifetime by bringing it to your local collection point or recycling centre for such equipment.

Têtes de microphone ME 34, 35, 36

- Microphones électrostatiques à polarisation permanente
- Domaines d'applications : conférences, installations de sonorisation et applications studio

ME 34, ME 35

- ME 34: directivité cardioïde
- ME 35: directivité supercardioïde
- Solide boîtier métallique, surface anti reflet, noir mat
- Qualité sonore élevée
- Faible bruit de fond

ME 36

- Directivité supercardioïde/lobe
- Solide boîtier métallique, surface anti reflet, noir mat
- Directivité prononcée
- Qualité sonore maximale
- Très faible bruit de fond

Branchements possibles

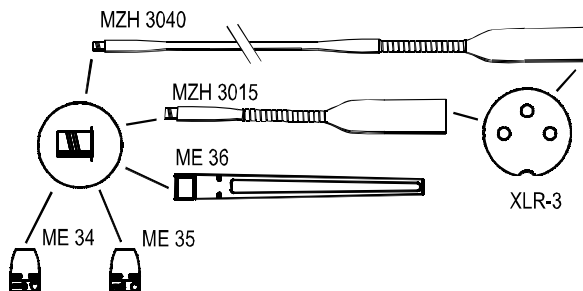

Note

Pour établir une liaison de masse intacte, il faut absolument visser le microphone au col de cygne.

Accessoires

Accessoire	Nom	N° Réf.
Cols de cigne	MZH 3015	005074
	MZH 3040	005076
	MZH 3042	009384
Bonnette anti-vent	MZW 34 W blanche	005068
	MZW 34 PRO noire	005067
	MZW 34 noire	086740
	MZW 36 PRO noire	005069
	MZW 36 noire	083297
Fixation anti-vibration	MZS 31	005087
Variantes d'anneau lumineux	MZH 3015L	009435
	MZH 3040L	009436
	MZH 3042L	009437

Cols de cygne MZH 3015, MZH 3040 et MZH 3042

- Cols de cygne pour utilisation avec les microphones ME 34, ME 35 et ME 36
- Col métallique, solide boîtier métallique, surface anti reflet, noir mat
- Connexion micro standard (XLR-3)

	MZH 3015	MZH 3040	MZH 3042
Longueur	150 mm	400 mm	400 mm
Diamètre	6 mm	6 mm	6 mm
Poids	73 g	120 g	110 g
Connecteur	XLR-3	XLR-3	XLR-3

Connecteurs XLR-3

Les cols de cygne sont équipés des sorties XLR symétriques, sans mise à la terre, avec polarisation normalisée.

Spécifications

En combinaison avec MZH 3015, MZH 3040 et MZH 3042

	ME 34	ME 35	ME 36
Réponse en fréquence	40 Hz – 20 kHz	50 Hz – 20 kHz	40 Hz – 20 kHz
Principe acoustique	gradient de pression	gradient de pression	gradient de pression/tube d'interférence
Directivité	cardioïde	supercardioïde	supercardioïde/lobe
Sensibilité (champ libre, hors charge)	10 mV/Pa	10 mV/Pa	18 mV/Pa
Impédance électrique	50 Ω	50 Ω	50 Ω
Impédance mini de charge	1 k Ω	1 k Ω	1 k Ω
Bruit équivalent	37 dB (CCIR) 26 dB(A)	37 dB (CCIR) 26 dB(A)	34 dB (CCIR) 23 dB(A)
Alimentation	P12 – P48	P12 – P48	P12 – P48
Dimensions en mm	\varnothing 12 x L18	\varnothing 12 x L18	\varnothing 8,2 x L96
Poids (sans MZH)	9,5 g	9,5 g	17 g
Connecteur	XLR-3	XLR-3	XLR-3

Déclarations du fabricant

Garantie

2 ans

Certification

 Sennheiser electronic GmbH & Co. KG déclarons que cet appareil est en conformité avec les normes CE.

WEEE Déclaration



En fin de vie veuillez rapporter cet appareil à la déchetterie communale ou à un centre de recyclage.

Capsole microfoniche ME 34, ME 35, ME 36

- Microfoni a condensatore
- L'utilizzo in conferenze, registrazioni, studi di post produzione, etc.

ME 34, ME 35

- ME 34: caratteristica cardioide
- ME 35: caratteristica supercardioide
- Alloggiamento in metallo stabile, superficie non riflettente, nero opaco
- Elevata qualità sonora
- Basso livello di rumore di fondo

ME 36

- Caratteristica raggio supercardioide
- Alloggiamento in metallo stabile, superficie non riflettente, nero opaco
- Eccellente qualità sonora
- Bassissimo livello di rumore di fondo

Collegamenti

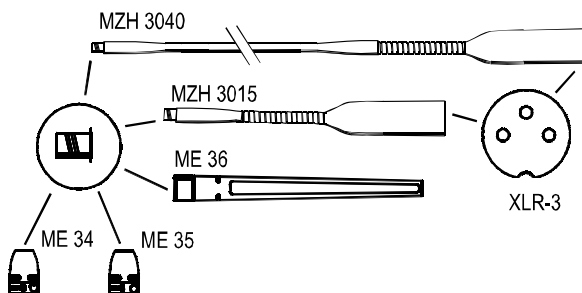

Nota

Per stabilire un buon collegamento a massa, è indispensabile avvitare saldamente il microfono sul collo di cigno.

Accessori

Articolo	Denominazione	N. art.
Colli di cigno	MZH 3015	005074
	MZH 3040	005076
	MZH 3042	009384
Protezione antivento	MZW 34 W bianco	005068
	MZW 34 PRO nero	005067
	MZW 34 nero	086740
	MZW 36 PRO nero	005069
	MZW 36 nero	083297
Supporto antivibrazioni	MZS 31	005087
Varianti con anello luminoso	MZH 3015L	009435
	MZH 3040L	009436
	MZH 3042L	009437

Colli di cigno per capsule microfoniche MZH 3015, MZH 3040 e MZH 3042

- Colli di cigno da utilizzare con le capsule ME 34, ME 35 e ME 36
- Alloggiamento in metallo stabile, superficie non riflettente, nero opaco
- Connettore standard (XLR-3) per microfoni

	MZH 3015	MZH 3040	MZH 3042
Lunghezza	150 mm	400 mm	400 mm
Diametro (collo)	6 mm	6 mm	6 mm
Peso	73 g	120 g	110 g
Collegamento	XLR-3	XLR-3	XLR-3

Connettori standard XLR-3

I connettori di uscita dei colli di cigno sono cablati simmetricamente senza messa a terra e polarizzati secondo le norme.

Dati tecnici

Dati tecnici in combinazione con MZH 3015, MZH 3040 e MZH 3042

	ME 34	ME 35	ME 36
Gamma di frequenza	40 Hz – 20 kHz	50 Hz – 20 kHz	40 Hz – 20 kHz
Caratteristica acustica	trasduttore a gradiente di pressione	trasduttore a gradiente di pressione	trasduttore a gradiente di pressione
Direttività	cardioide	supercardioide	supercardioide / clava
Sensibilità	10 mV/Pa	10 mV/Pa	18 mV/Pa
Impedenza elettrica	50 Ω	50 Ω	50 Ω
Impedenza di caricominima	1 k Ω	1 k Ω	1 k Ω
Livello di rumore equivalente	37 dB (CCIR) 26 dB(A)	37 dB (CCIR) 26 dB(A)	34 dB (CCIR) 23 dB(A)
Alimentazione	P12 – P48	P12 – P48	P12 – P48
Dimensioni (mm)	\varnothing 12 x L18	\varnothing 12 x L18	\varnothing 8,2 x L96
Peso (senza MZH)	9,5 g	9,5 g	17 g
Connettore	XLR-3	XLR-3	XLR-3

Dichiarazione del costruttore

Garanzia

2 anni

Certificazione

CE Sennheiser electronic GmbH & Co. KG dichiara che questo apparecchio è conforme alle normative e alle prescrizioni CE applicabili.

Dichiarazione WEEE



Alla fine del loro utilizzo vi preghiamo di smaltire questo apparecchio negli appositi punti di raccolta locali o nei centri preposti al riciclaggio.

Cabezas de micrófono ME 34, ME 35, ME 36

- Cabezas de micrófono de condensador polarizadas permanentemente
- Utilización: para conferencias, sonorización, técnica de estudios de grabación

ME 34, ME 35

- ME 34: característica cardioide
- ME 35: característica supercardioide
- Robusta caja metálica, superficie antirreflejante, negro mate
- Magnífica calidad del sonido
- De poco ruido

ME 36

- Característica cardioide en forma de lóbulo
- Robusta caja metálica, superficie antirreflejante, negro mate
- Alto grado de concentración
- Sobresaliente calidad del sonido
- Mínimo ruido

Posibilidades de conexión

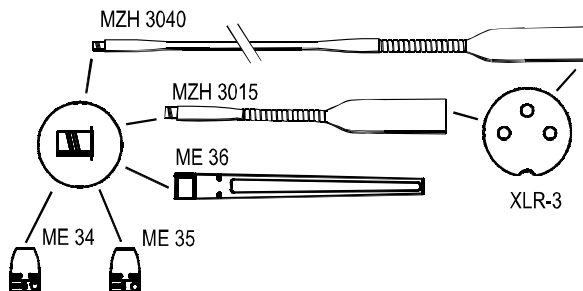

Nota

Para establecer una conexión a masa intacta, es absolutamente necesario atornillar el micrófono firmemente en el cuello de cisne.

Accesorios

Artículo	Denominación	Núm.art.
Cuellos de cisne	MZH 3015	005074
	MZH 3040	005076
	MZH 3042	009384
Pantalla contra el viento	MZW 34 W blanco	005068
	MZW 34 PRO negro	005067
	MZW 34 negro	086740
	MZW 36 PRO negro	005069
	MZW 36 negro	083297
Soporte giratorio	MZS 31	005087
Variantes de anillo luminoso	MZH 3015L	009435
	MZH 3040L	009436
	MZH 3042L	009437

Cuellos de cisne MZH 3015, MZH 3040 y MZH 3042

- Cuellos de cisne utilizables con los micrófonos ME 34, ME 35 y ME 36
- Cuello metálico, robusta caja metálica, superficie antirreflejante, negro mate
- Conexión estándar para micrófono (XLR-3)

	MZH 3015	MZH 3040	MZH 3042
Largo	150 mm	400 mm	400 mm
Diámetro (cuello)	6 mm	6 mm	6 mm
Peso	73 g	120 g	110 g
Conexión	XLR-3	XLR-3	XLR-3

Conexiones XLR-3

Los enchufes de salida de los cuellos de cisne están simétricamente aislados de tierra y polarizados conforme a la norma.

Datos técnicos

Junto con los modelos MZH 3015, MZH 3040 y MZH 3040

	ME 34	ME 35	ME 36
Margen de transmisión	40 Hz – 20 kHz	50 Hz – 20 kHz	40 Hz – 20 kHz
Funcionamiento o acústico	Receptor de gradiente de presión	Receptor de gradiente de presión	Receptor de gradiente de presión/Tubo de dirección de interferencia
Característica direccional	Cardioide	Supercardioide	Supercardioide/lóbulo
Factor de eficacia en el campo acústico libre	10 mV/Pa	10 mV/Pa	16 mV/Pa
Impedancia eléctrica	50 Ω	50 Ω	50 Ω
Impedancia final mín.	1 k Ω	1 k Ω	1 k Ω
Nivel sonoro sustitutivo	37 dB (CCIR) 26 dB(A)	37 dB (CCIR) 26 dB(A)	34 dB (CCIR) 23 dB(A)
Alimentación de corriente	P12 – P48	P12 – P48	P12 – P48
Medidas (mm)	\varnothing 12 x L18	\varnothing 12 x L18	\varnothing 8,2 x L96
Peso (sin MZH)	9,5 g	9,5 g	17 g
Conexión	XLR-3	XLR-3	XLR-3

Declaración del fabricante

Garantía

2 años

Autorización

CE Sennheiser electronic GmbH & Co. KG declara que este aparato cumple las normas y directrices de la CE aplicables.

WEEE Declaración



Al final de su vida útil, lleve este aparato al punto de recogida de su municipio o a un centro de reciclaje.



Microfoonkoppen ME 34, ME 35, ME 36

- Constant gepolariseerde condensatormicrofoons
- Toepassingsgebieden, conferenties, overspoelen met geluid, studietechniek

ME 34, ME 35

- ME 34: Nier-karakteristiek
- ME 35: Supernier-karakteristiek
- Stabiele metaalbehuizing, niet reflecterend oppervlak, matzwart
- Hoge klankkwaliteit
- Ruisarm

ME 36

- Supernier-kegelkarakteristiek
- Stabiele metaalbehuizing, niet reflecterend oppervlak, matzwart
- Hoge richtingsfactor
- Uitstekende klankkwaliteit
- Erg ruisarm

Aansluitingsmogelijkheden

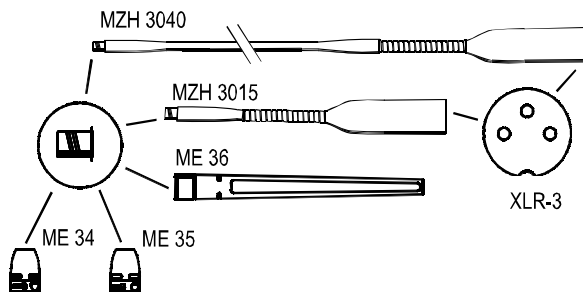

Opmerking

Om een intacte massaverbinding te maken, dient u de microfoon in elk geval stevig op de zwanenhals vast te schroeven.

Accessoires

Artikel	Benaming	Art.nr.
Zwaanshalsen	MZH 3015	005074
	MZH 3040	005076
	MZH 3042	009384
Windbescherming	MZW 34 W wit	005068
	MZW 34 PRO swart	005067
	MZW 34 swart	086740
	MZW 36 PRO swart	005069
	MZW 36 swart	083297
Slingersteun	MZS 31	005087
Lichtringvarianten	MZH 3015L	009435
	MZH 3040L	009436
	MZH 3042L	009437

Zwaanshalsen MZH 3015, MZH 3040 en MZH 3042

- Zwaanshalsen voor het gebruik met de microfoons ME 34, ME 35 en ME 36
- Stabiele metaalbehuizing, niet reflecterend oppervlak, matzwart
- Standaard microfoonaansluiting (XLR-3)

	MZH 3015	MZH 3040	MZH 3042
Lengte	150 mm	400 mm	400 mm
Diameter (hals)	6 mm	6 mm	6 mm
Gewicht	73 g	120 g	110 g
Aansluiting	XLR-3	XLR-3	XLR-3

XLR-3 aansluitingen

Die uitgangconnectoren van de zwaanshalsen zijn symetrisch en niet-geaard geschakeld en volgens de normen gepoold.

Technische gegevens

In combinatie met MZH 3015, MZH 3040 en MZH 3042

	ME 34	ME 35	ME 36
Overdrachtsgebied	40 Hz – 20 kHz	50 Hz – 20 kHz	40 Hz – 20 kHz
Akoestische werkwijze	Drukgradient-ontvanger	Drukgradient-ontvanger	Drukgradient-ontvanger/ interferentie-richtbuis
Richtkarakteristiek	Nier	Supernier	Supernier/ kegel
Overdrachtsfactor onbelaste werking	10 mV/Pa	10 mV/Pa	16 mV/Pa
Elektrische impedantie	50 Ω	50 Ω	50 Ω
Min. afsluitimpedantie	1 k Ω	1 k Ω	1 k Ω
Geluidsdruk-niveau	37 dB (CCIR) 26 dB(A)	37 dB (CCIR) 26 dB(A)	34 dB (CCIR) 23 dB(A)
Stroomtoevoer	P12 – P48	P12 – P48	P12 – P48
Afmetingen (mm)	\varnothing 12 x L18	\varnothing 12 x L18	\varnothing 8,2 x L96
Gewicht (zonder MZH)	9,5 g	9,5 g	17 g
Aansluiting	XLR-3	XLR-3	XLR-3

Verklaringen van de fabrikant

Garantie

2 jaar

Vergunning

CE Sennheiser electronic GmbH & Co. KG verklaren, dat dit toestel voldoet aan de toepasselijke CE-normen en voorschriften.

WEEE-verklaring



Breng dit apparaat aan het einde van zijn levensduur naar een van de plaatselijke verzamelpunten of naar een kringloopwinkel.

Diagramme / Diagrams / Diagrammes / Diagrammi / Diagramas / Diagrammen

Polardiagramm ME 34 / Polar Diagram ME 34
Diagramme polaire ME 34 / Diagramma polare ME 34
Diagrama polar ME 34 / Pooldiagram ME 34

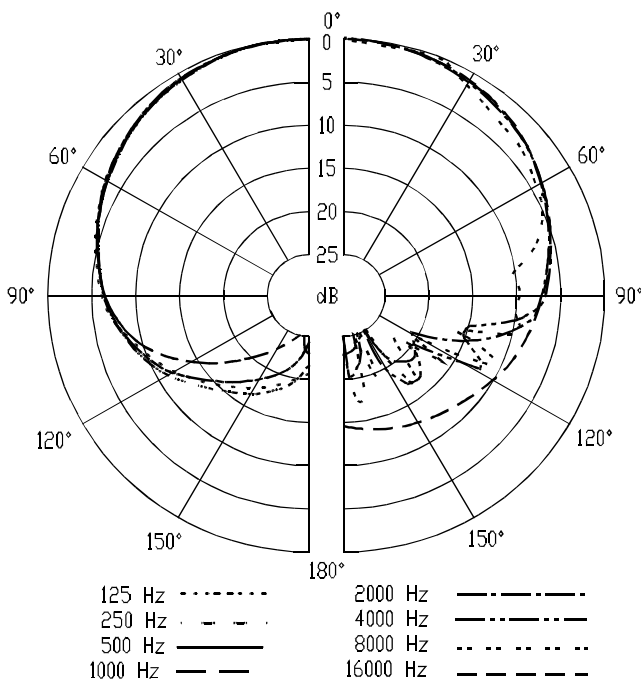

Polardiagramm ME 35 / Polar Diagram ME 35

Diagramme polaire ME 35 / Diagramma polare ME 35

Diagrama polar ME 35 / Pooldiagram ME 35

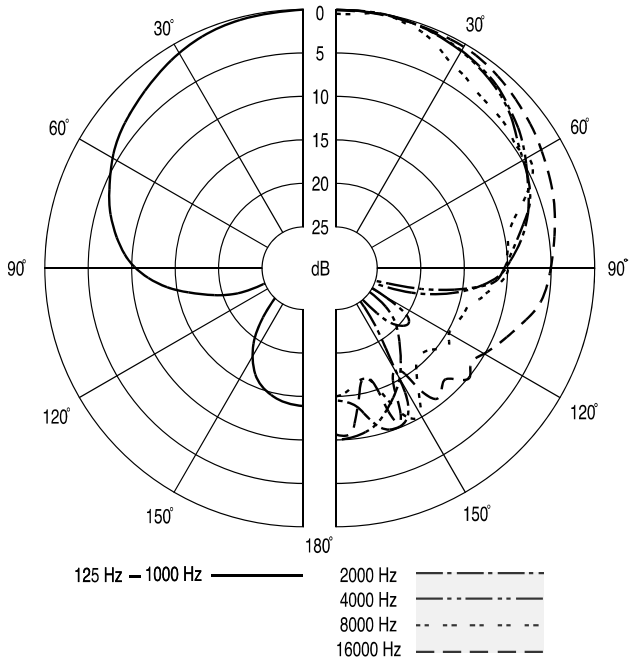

Polardiagramm ME 36 / Polar Diagram ME 36
Diagramme polaire ME 36 / Diagramma polare ME 36
Diagrama polar ME 36 / Pooldiagram ME 36

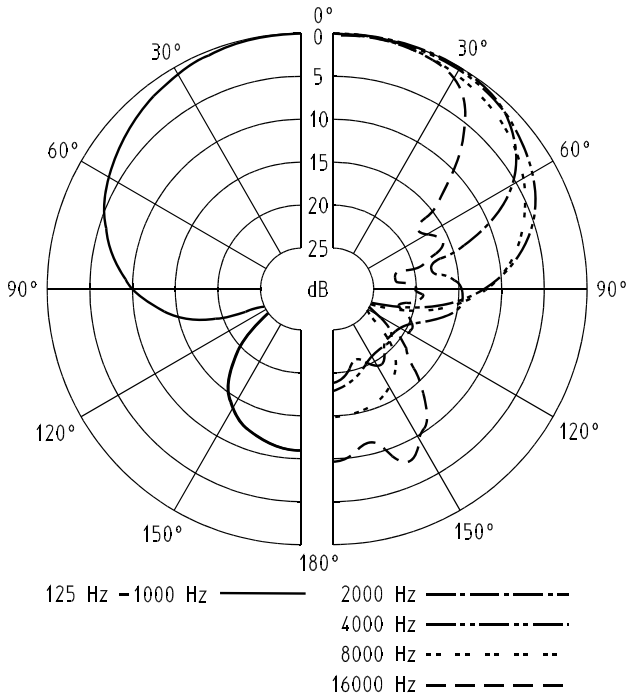

Frequenzdiagramm ME 34
Frequency response curve ME 34
Courbe de réponse ME 34
Diagramma della risposta in frequenza ME 34
Diagrama de frecuencia ME 34
Frequentiediagramm ME 34

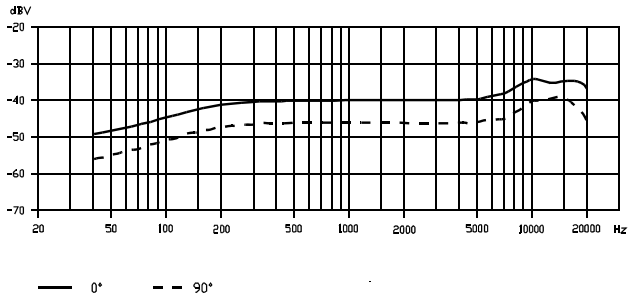

Frequenzdiagramm ME 35
Frequency response curve ME 35
Courbe de réponse ME 35
Diagramma della risposta in frequenza ME 35
Diagrama de frecuencia ME 35
Frequentiediagramm ME 35

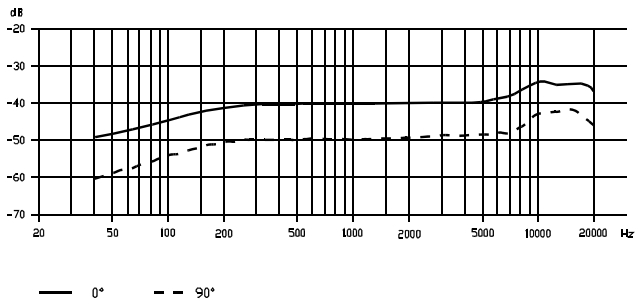

Frequenzdiagramm ME 36
Frequency response curve ME 36
Courbe de réponse ME 36
Diagramma della risposta in frequenza ME 36
Diagrama de frecuencia ME 36
Frequentiediagramm ME 36

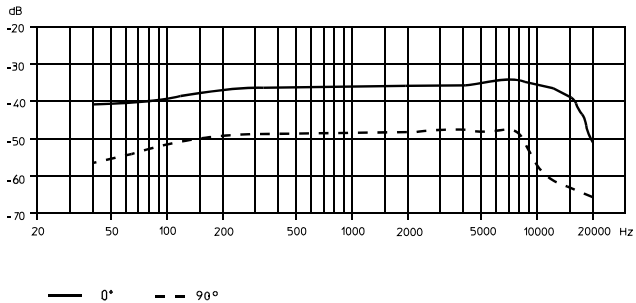

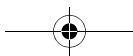
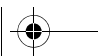
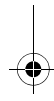
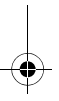
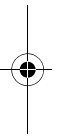
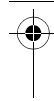
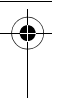



Sennheiser electronic GmbH & Co. KG
30900 Wedemark, Germany
Phone +49 (5130) 600 0
Fax +49 (5130) 600 300
www.sennheiser.com

Printed in Germany

Publ. 07/06

85344/A03