

*Spécial Disco Series*

DJ'S MIKE

1

2



TALK OVER

3



MIKE LEVEL

4



LEVEL

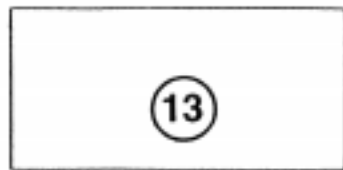

13

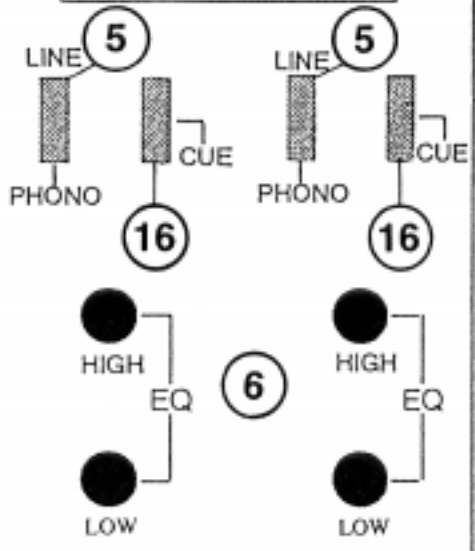

GAIN

7

GAIN

A

B

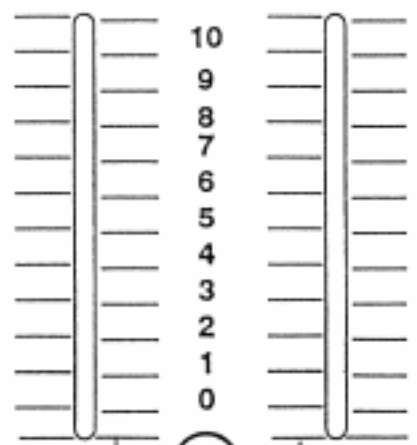

8

A

B

11



-PUNCH-

11



-PUNCH-

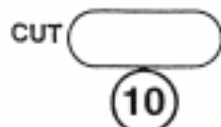

10

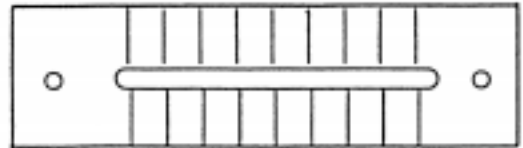

SUPER CROSS FADER

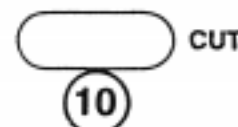

10

POWER

12

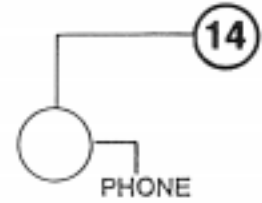

PHONE

CUE LEVEL

15

MASTER

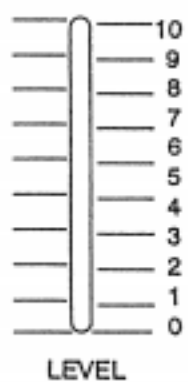

LEVEL

17

